

50IU-FM04 Installation Guide

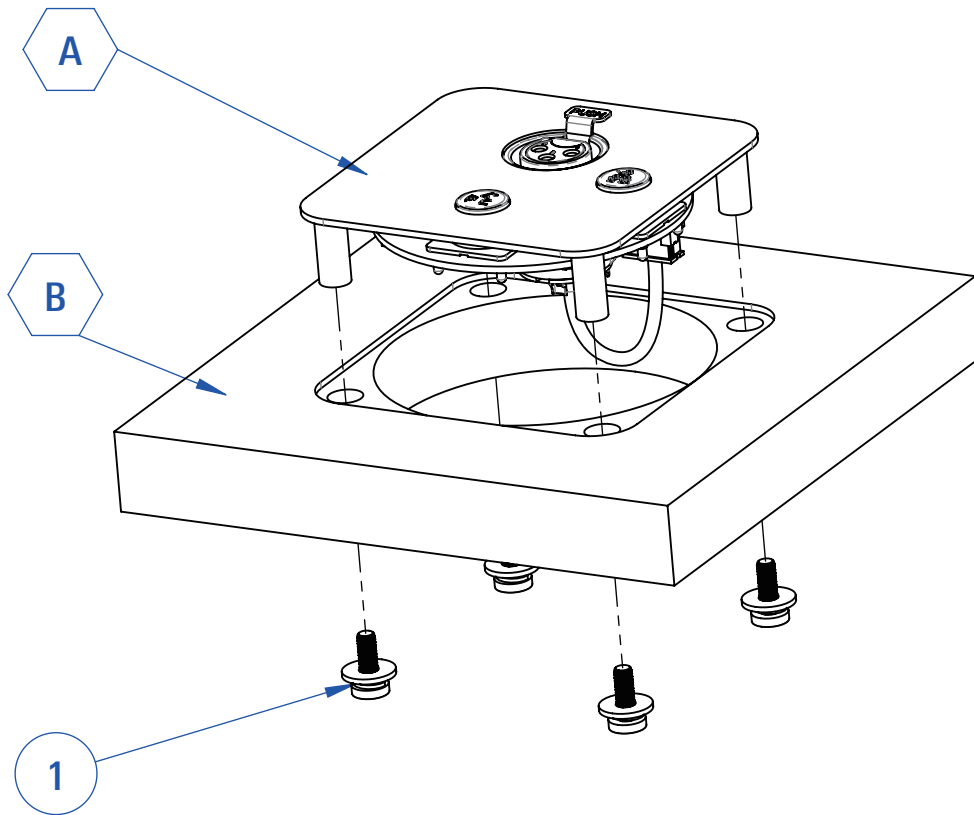

A	50IU-FM04 Insert unit
B	Recommend table top thickness = T T = 19mm (3/4") T = 25mm (1") T = 38mm (1-1/2") T = 50mm (2")

1	Machine screw with spring & flat washer	
a	M4 × 12 for T = 19mm (3/4")	5
b	M4 × 18 for T = 25mm (1")	5
c	M4 × 31 for T = 38mm (1-1/2")	5
d	M4 × 44 for T = 50mm (2")	5

Table top hole cut dimensions

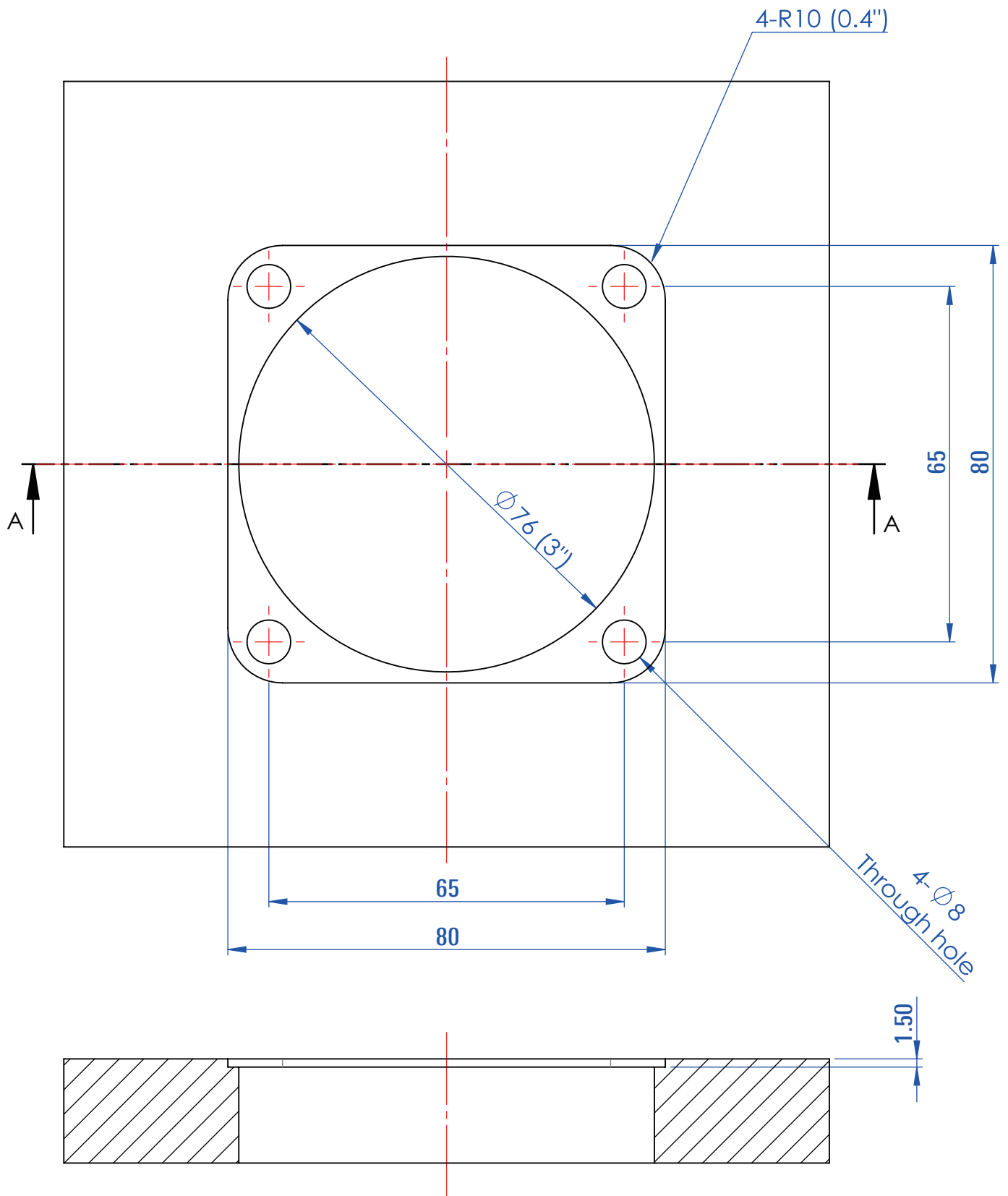

SECTION A-A